

Manholes

Sanitary Manholes	145
Pneumatic Manholes	145
Misc. Dome Gaskets	146
Sanitary Manhole Replacement Parts for Tremcar, Walker and Brenner	146
Plug Assembly	146
Betts Petroleum Manholes	147-152
Betts 10" Fill Model 8010.....	147
Betts 10" PAF 406-98 Pressure Relief Valve.....	147
Betts 4" Surge Suppression Valve.....	147
12" X 16" Elliptical Inspection Manhole Model 8060.....	148
12" X 16" Elliptical Manhole with 10" Fill Model 8012.....	148
Betts 12" X 16" Elliptical PAF1000 Manhole with Pressure Relief Valve.....	148
Betts 12" X 16" Elliptical PAF450 Manhole with Pressure relief Valve.....	148
Betts 12" Elliptical PAF 406-98 Manhole with Integral Relief Valve Model L712-Standard.....	149
16" Round Inspection Manhole.....	149
Betts 16" Round Manhole with 10" Fill.....	149
Betts 16" & 20" PAF450 Manhole with Pressure Relief Models: Standard and Self-Latching..	150
Betts 16" & 20" Hot Product Manhole with 10" Fill.....	150
16" & 20" Manhole - Standard/Fill Style with 8" Surge Suppression Relief Valve.....	151
16" & 20" Manhole - Standard/Bolted Style with 8" Surge Suppression Relief Valve.....	151
Betts 16" & 20" PAF 406-98 Manhole with Integral Relief Valve/10" Fill.....	152
Betts 16" & 20" PAF 306-98 Manhole with Integral Relief Valve/10" Fill.....	152
Betts Chemical Manholes	153-155
Betts 10" Pressure Fill Model 8370.....	153
Betts 20" Full Opening Manhole Model 8310.....	153
Betts 20" Full Opening Manhole Model 8327.....	153
Betts 10" Pressure Fill (ASME Type) Model 8368.....	153
10" Pressure Fill (ASME Type) Model 8369.....	153
20" Full Opening Manhole with 10" Fill (ASME Type) Model 8387.....	153
20" Full Opening Manhole (ASME Type) Model 8350.....	153
20" Full Opening Manhole Model 8355.....	153
10" Pressure Fill (ASME Type) Model 8261.....	154
20" Full Opening Manhole (ASME Type) Model 8205.....	154
20" Full Opening Manhole with 10" Fill (ASME Type) Model 8260.....	154
20" Full Opening Manhole (ASME Type) Model 8380.....	154
24" Full Opening Manhole (ASME Type) Model 8324.....	154
16" Full Opening Manhole (ASME Type) Model 8303.....	154
18" Full Opening Manhole (ASME Type) Model 8418.....	154
Betts 20" Full Opening Manhole with 10" Relief Valve (PAF 450 Style) Model 9730.....	155
Betts 20" Full Opening Manhole with 8" Relief Valve Model 8311.....	155

Betts Sanitary Manway Assembly

The Betts Sanitary Manway is designed and manufactured to meet the vigorous requirements of the sanitary industry. All product contact surfaces are mechanically polished to a #4 finish and the entire manway is electro-polished to a lustrous finish. The electro-polished finish provides improved corrosion resistance and easier cleaning.

The manway features a 7 gauge collar, 10 gauge stud platform, 10 gauge inner head, and a 12 gauge dustcover. The double gusseted $\frac{3}{4}$ " stub ACME studs are accompanied by heavy-duty hold-down dogs and easy grip wing-nuts with brass inserts. The gasket has a sealing lip to reduce leakage due to surge.

The stud platform has a mounting lip for ease of fit-up with a rectangular deck plate. An optional 14 gauge circular fit-up sleeve (**part# 6796SL**) is sold separately for a direct connection to tank outer shell.

Please refer to **Appendix C-4** for parts breakout and replacement parts

Built in Accordance with 3-A Sanitary Standard
Tamper Resistant
304L Stainless Steel Construction
Five $\frac{3}{4}$ " Stub ACME Hold-Downs
Surge Resistant Design
#4 Ground Finish on all Product
Contact Surface
All Surfaces Electropolished
Double Capacity Breather Grommet
Capable of Air Flow of 5,500 SCFH @ tank
pressure 1 psig & 12,500 SCFH @ 2 psig
Breather Grommet completely protected
under the hinge



Heil/Knappco Manhole

20" Knappco aluminum 6 lug manhole used on Heil and other dry bulk trailers.

For a full parts breakout please refer to **Appendix C-54**



Butler Aluminum Manhole

Butler style 6-cam manhole for dry bulk applications. DBL offers all assemblies and spare parts for this series of manholes. Please refer to appendix for a full breakdown of replacement parts.

For a full parts breakout please refer to **Appendix C-1**



Betts Sanitary Dome Breather

Part# **BET4217WE**

White Nitrile rectangular breather for Betts sanitary dome lid.



Vent Dust Cover

Part# **GASS285**

White Nitrile round breather Walker Sanitary dome lid.



Sanitary Dome Gaskets and Seals

Part#	Description
GASDOMEBESAN	Betts Dome Seal
GASDOMBRESAN	Brenner Dome Lid Seal
GASDOMEHEISAN	Heil Gasket
GASDOMEKARSAN	Karikool Dome Gasket
GASDOMESTESAN	Polar Dome Gasket
GASDOMETRESAN	Tremcar Dome Gasket
GASDOMEWALSAN	Walker Dome Gasket

Knappco 10" Fill Gasket

Part# **GASFILLKN**

Buna-N gasket used in conjunction with Knappco petroleum manway.

Brenner Hold Down Lug and Wing Nut

Parts for old and new style Brenner manways.



Clay and Bailey Gaskets

Cork gaskets used on Clay and Bailey cast-type oval manholes.



Part#	Description
MISBRE-CPA49	5/8" Hold Down Lug
MISBRE-HAA24	5/8" Wing Nut
MISBRE-CPA929	3/4" Hold Down Lug
MISBRE-HAA359	3/4" Hold Down Lug

Tremcar Manhole Nut and Cover Latch

Dome cover hold down equipment for sanitary manhole.



Walker Sanitary Manhole

Stainless steel sanitary manhole and duster cover for Walker food grade trailer.



Part#	Description
MISTRSTBT020A	Nut
MISTRSTBT021A	Cover Latch

Part#	Description
WALMWY0094	Latch Dog
WALMWY3335	Hinge Pin
WALMWYA3064	Cover
WALMWYA3070	Dust Cover
WALMWYA3083	Wing Nut

Bellseng Pressure Lock Lid Seal

Black Nitrile gaskets for air operated dome lids on dry bulk product trailers.



Betts 2" Plug Assembly

Part# **BET17158ALT**

Aluminum plug with Buna gasket and lock ring to seal sensor hole in Betts dome lids.



Part#	Description
GASDOMESOLI	Inner Lid Seal
GASDOMESOLO	Outer Lid Seal

Betts 10" Fill Model 8010

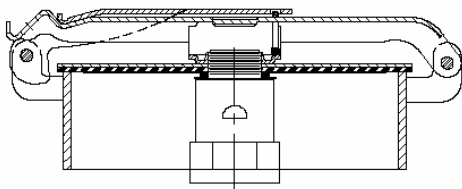

Model 8010

Light weight, simple construction, less maintenance, and a low silhouette. The 10" is fabricated for lighter weight and greater strength. Heavy gauge collar is standard along with the secondary safety latch and a long lasting Bethane gasket. Other gaskets also available.

For ordering information please refer to **Appendix S-1**

For replacement parts please refer to **Appendix C-5**

Betts 10" PAF 406-98 Pressure Relief Valve

The 10" relief valve provides emergency pressure relief and meets the 1 liter surge leakage limit imposed by DOT 406 Specifications in 49CFR178.345-10(b)(3)(ii). Also legal for replacement on MC306 specification cargo tanks. The relief valve also serves as a 10" latch style fill which can be easily opened to provide access for filling the tank or for inspection. Relief valves contain an adjustment feature to allow for fine-tuning of set pressure in the field. Other standard features include **Model 6496ALB** pressure-vacuum vent mounted in the 10" relief valve cover.

Pressure relief valve setting 3.63 psig., rated pressure actuated emergency venting: 494,084 cu. ft. free air per hour @ 6.25 psig. Rated liquid flow capacity 1335 GPM @ 5.0 psig.

For ordering information please refer to **Appendix S-1**

Please refer to **Appendix C-6** for replacement parts

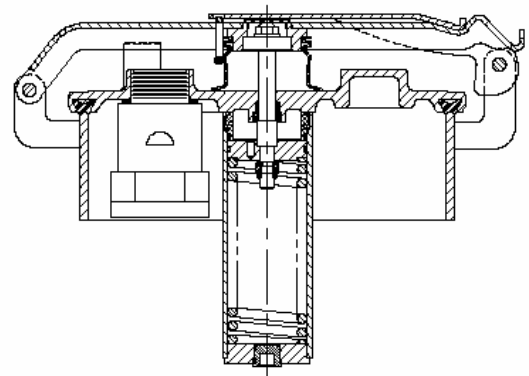

Betts 4" Surge Suppression Valve

Dual rated MC306/DOT406, no liquid loss at impact, aluminum Construction.

Betts 4" Surge Suppression Pressure Relief Valve are designed to provide or augment the emergency venting capacity required for either MC306 or DOT406 specification cargo tanks. Because they release no liquid during the DOT specified pressure surge, the pressure relief valves exceed the requirements of 49 CFR 178.345-10(b)(3)(ii) which requires that pressure relief devices withstand a specified pressure surge with no more than one liter leakage.

Model 8292ALTS mounts in a special 20" offset PAF manhole and **Model 8290ALTS** mounts on either Betts **Model 6516** weld pad or a standard TTMA 4" weld flange. Both models are constructed of aluminum, stainless steel, zinc plated steel and Tef-Sil seals.

For ordering information please refer to **Appendix S-1**

Please refer to **Appendix K-33** for replacement parts

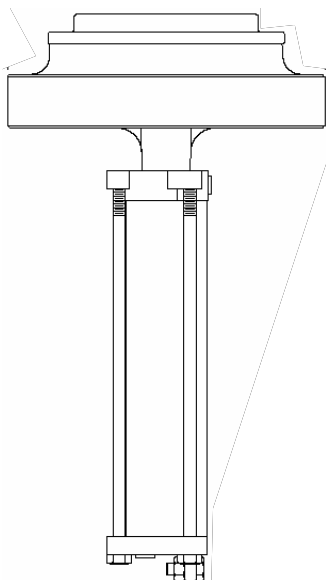

12" X 16" Elliptical Inspection Manhole (Model 8006)

Light weight, less maintenance, and low cost. For use where elliptical shape can be of advantage for special design. Easy opening and positive closing features. **Betts Model 8006 is available in several choices of materials.**

For ordering information please refer to **Appendix S-1**

For Replacement parts refer to **Appendix C-7**

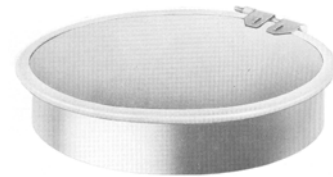
**12" X 16" Elliptical Manhole with 10" Fill (Model 8012)**

Betts' fabricated construction assures quick and easily welded installation. Oval shape offers flexibility in designing equipment and most efficient operation. A secondary Latch is standard on all assemblies.

For ordering information please refer to **Appendix S-1**

For a full list of replacement parts see **Appendix C-8**

Betts 12" X 16" Elliptical PAF1000 Manhole with Pressure Relief Valve (Model 8412)

This model has become obsolete, but replacement parts are still available, but may be discontinued at anytime. Please refer to the parts list for a full breakdown.

For ordering information please refer to **Appendix S-1**

For a full list of replacement parts refer to **Appendix C-9**

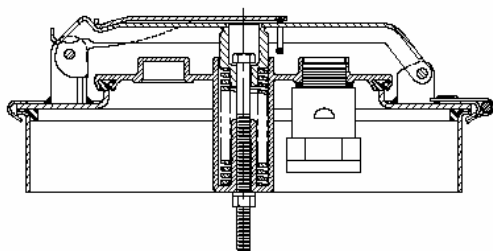

NORMAL VENT
WROUGHT STEEL COVER
SECONDARY SAFETY LATCH
HEAVY DUTY CLAMP RING

Betts 12" X 16" Elliptical PAF450 Manhole with Pressure Relief Valve Model 9712

PAF Manholes with Model PAF450 10" Pressure Relief Valve are certified for use on MC306 cargo tanks. Manholes are certified and marked in accordance with 49CFR178.345-5 with a test pressure of 36 psig.

Per 49CFR180.405(h)(3), PAF450 assemblies may not be installed on MC306 cargo tanks after August 31, 1998. However, relief valves installed on MC306 cargo tanks on or before August 31, 1998, may be repaired if required. PAF450 relief valves may be installed in non-specification tanks or in tanks built in countries other than the United States where regulations permit.

Relief valve also serves as a 10" latch style fill which can be easily opened for filling the tank or for inspection. Standard features include heavy duty clamp ring, secondary safety latch and **Model 6238AL** Normal Vent.

For ordering information please refer to **Appendix S-2**

For a full list of replacement parts please refer to **Appendix C-10**

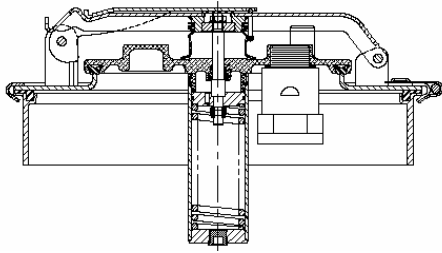

INTEGRAL RELIEF VALVE/10" FILL
LESS THAN 1 LITER LEAKAGE
SET PRESSURE ADJUSTMENT
INCREASED FLOW RATE
SECONDARY SAFETY LATCH

Betts 12" X 16" Elliptical PAF 406-98 Manhole with Integral Relief Valve Model L712-Standard

PAF manholes with integral latch style surge suppression relief valves are designed for use on DOT406 and replacement on MC306 specification cargo tanks. Elliptical manholes can only be used with compartments less than 400 gallons. Manholes are certified and marked in accordance with 49CFR178.345-5 with a test pressure of 36 psig. Manhole covers are 7 gauge steel or stainless and are secured to the tank weld collar with a clamp ring and bolt which can be easily removed to provide access into the tank.

The integral 10" relief valve provides emergency pressure relief and meets the 1 liter surge leakage limit imposed by 49CFR178.345-10(b) (3)(ii). The relief valve also serves as a 10" latch style fill which can be easily opened to provide access for filling the tank or for inspection. Relief valves contain an adjustment feature to allow for fine-tuning of set pressure in the field. Other standard features include a heavy duty clamp ring, secondary safety latch and **Model 6496ALB** pressure-vacuum vent mounted in the 10" relief valve cover.

For ordering information please refer to **Appendix S-2**
For replacement parts please refer to **Appendix C-11**

16" and 20" Round Inspection Manhole

Easily installed, less maintenance, and low cost. Made of heavy gauge metal and welded construction minimizes maintenance.

For ordering information please refer to **Appendix S-2 and S-5**
For a list of gaskets and other replaceable parts please refer to **Appendix C-12 and C-25**

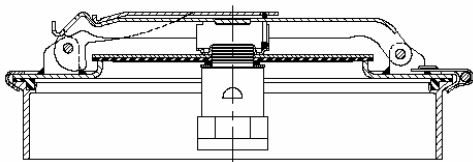

LIGHT WEIGHT
LESS MAINTENANCE
LOW SILHOUETTE

Betts 16" and 20" Round Manhole with 10" Fill Model 8016

The 16" Manhole is fabricated for lighter weight and greater strength. The advanced design has low silhouette and clean lines. Fill gasket will not pull out; is easily replaced. To compensate for wear, tension on fill cover is easily adjusted by adding shim washers. Hinge pins welded in place to prevent removal. Adequate means provided for use of seal wire. One outside clamping ring provides means for attaching cover to collar. Cover may be oriented throughout 360°. Secondary Latch is standard on all assemblies. A heavy-duty 20" model is also available.

For ordering information please refer to **Appendix S-2 and S-5**
For a list of gaskets and other replaceable parts please refer to **Appendix C-13 and C-26**

**Betts 16" & 20" PAF450 Manhole with Pressure Relief Valve
Models: Standard and Self-Latching**

PAF Manholes with Model PAF450 10" Pressure Relief Valve are certified for use on MC306 cargo tanks. Manholes are certified and marked in accordance with 49CFR178.345-5 with test pressure of 36 psig.

Per 49CFR180.405(h)(3), PAF450 assemblies may not be installed on MC306 cargo tanks after August 31, 1998. However, relief valves installed on MC306 cargo tanks on or before August 31, 1998, may be repaired if required. PAF450 relief may be installed on non-specification tanks or in tanks built in countries other than the United States where regulations permit.

Relief valve also serves as a 10" latch style fill which can be easily opened for filling the tank or for inspection. Standard features include heavy duty clamp ring, secondary safety latch and **Model 6238AL** Normal Vent. Manholes are also available with a self-latching feature which allows the Pressure Relief Valve cover to open only 91° and drop closed and securely latch upon movement of the tank if the cover is inadvertently left open. *No provision has been made for venting of product due to overfilling.

For a complete breakdown of replacement parts on all available models please refer to **Appendix C-14, C-15, C-27, and C-28**

For ordering information on all available models please refer to **Appendix S-2, S-3, and S-5**



NORMAL VENT
WROUGHT STEEL COVER
SECONDARY SAFETY
LATCH
HEAVY DUTY CLAMP RING

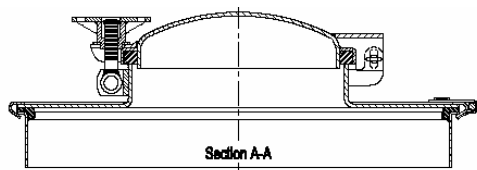

25 PSIG YIELD PRESSURE
MOUNT TO 20" PAF WELD COLLARS
HEAVY DUTY CLAMP RING



Betts 16" & 20" Hot Product Manhole with 10" Fill

Hot Product Manholes are designed for use on tanks hauling elevated temperature materials and are rated with a 25 PSIG yield pressure to meet the requirements of 49CFR 173.247(g)(2), which states:

"...Closures must be designed and constructed to withstand, without exceeding the yield strength of the packaging, twice the static loading produced by the lading in any packaging orientation and at all operating temperatures."

Hot Product Manholes are designed to retrofit existing PAF Manholes on elevated temperature tanks in order to bring them into compliance with the current closure requirements, as well as for new construction tanks.

he design features a 10" fill to provide tank access for filling or inspection and a heavy duty clamp ring which can be removed to provide access into the tank. Steel assemblies are black epoxy coated for corrosion resistance.

For a complete breakdown of replacement parts please refer to **Appendix C-16 and C-29**

For ordering information on all available models please refer to **Appendix S-3 and S-5**

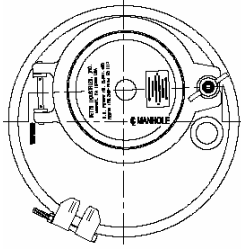

DUAL RATED DOT406/MC306
8" RELIEF VALVE WITH INTEGRAL
10" FILL
MEETS 49 CFR 178.345-10(b)(3)(ii)
NORMAL VENT WITH WEATHER
HOOD

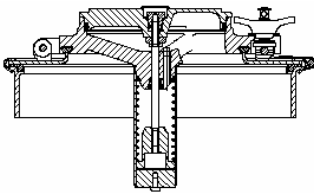

16" & 20" Manhole - Standard/Fill Style with 8" Surge Suppression Relief Valve

PAF manholes and 8" Surge Suppression Relief Valves are designed and certified for use on DOT406 and MC306 specification cargo tanks. Manholes are certified and marked as meeting 49CFR178.345-5 with a test pressure of 36 psig. Manhole covers are 7 gauge steel or stainless and are secured to the tank weld collar with a heavy duty clamp ring and bolt which can be easily removed to provide access into the tank.

The model 8276ALTS Surge Suppression Relief Valve provides emergency pressure relief and its dual ratings permit its use on both DOT406 and MC306 tanks. Surge Suppression Relief Valves meet the 1 liter surge leakage limit imposed by 49CFR178.345-10(b)(3)(ii). The relief valve also features a 10" fill which can be easily opened to provide access for filling the tank or for inspection. A secondary safety feature is built into the fill to prevent it from opening fully if it is released when the tank is pressurized. Surge Suppression Relief Valves are constructed of stainless steel and epoxy coated aluminum to minimize corrosion and feature Teflon encapsulated O-rings for compatibility with a wide range of products.

Available as an offset model

DBL offers a wide array of replacement parts, please refer to **Appendix C-17, C-18, C-30 and C-31** to see a breakdown of various models

For ordering information on these various 16" and 20" manholes please refer to **Appendix S-3 and S-6**

16" & 20 Manhole - Standard/Bolted Style with 8" Surge Suppression Relief Valve

PAF manholes and 8" Surge Suppression Relief Valves are designed and certified for use on DOT406 and MC306 specification cargo tanks. Manholes are certified and marked as meeting 49CFR178.345-5 with a test pressure of 36 psig. Manhole covers are 7 gauge steel or stainless and are secured to the tank weld collar with a heavy duty clamp ring and bolt which can be easily removed to provide access into the tank.

The **Model 8276ALTS** Surge Suppression Relief Valve provides emergency pressure relief and its dual ratings permit its use on both DOT406 and MC306 tanks. Surge Suppression Relief Valves meet the 1 liter surge leakage limit imposed by 49CFR178.345-10(b)(3)(ii). The relief valve is bolted to the manhole and can be removed from the manhole without entering the tank to provide an 8" opening in the manhole for inspection or adjustment of other accessories which may be mounted in the manhole. Surge Suppression Relief Valves are constructed of stainless steel and epoxy coated aluminum to minimize corrosion and feature Teflon encapsulated O-rings for compatibility with a wide range of products.

Available as an offset model

DBL offers a wide array of replacement parts, please refer to **Appendix C-19, C-20, C-32, and C-33** for various manhole configurations

For ordering information on these various 16" and 20" manholes please refer to **Appendix S-3, S-4, and S-6**

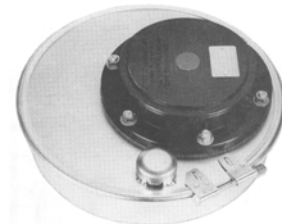

Standard/Fill Style

DUAL RATED DOT406/MC306
8" RELIEF VALVE WITH INTEGRAL
10" FILL
MEETS 49 CFR 178.345-10(b)(3)(ii)
NORMAL VENT WITH WEATHER
HOOD

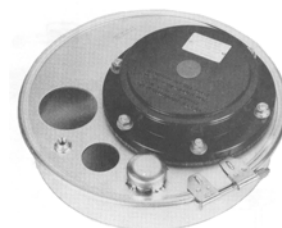

Offset/Fill Style

Betts 16" & 20" PAF 406-98 Manhole with Integral Relief Valve/10" Fill

PAF manholes with integral latch style surge suppression relief valves are designed for use on DOT406 and replacement MC306 specification cargo tanks. Manholes are certified and marked in accordance with 49CFR178.345-5 with a test pressure of 36 psig. Manhole covers are 7 gauge steel or stainless and are secured to the tank weld collar with a clamp ring and bolt which can be easily removed to provide access into the tank.

The integral 10" Relief Valve provides emergency pressure relief and meets the 1 liter surge leakage limit imposed by 49CFR178.345-10(b) (3)(ii). The relief valve also serves as a 10" latch style fill which can be easily opened to provide access for filling the tank or for inspection. Relief valves contain an adjustment feature to allow for fine tuning of set pressure in field. Other standard features include a heavy duty clamp ring, secondary safety latch and **Model 6496ALB** pressure-vacuum vent mounted in the 10" relief valve cover.

Manholes are available with a self-latching feature that allows the 10" relief valve/fill cover to drop and securely latch upon movement of the tank if the cover is inadvertently left open. For self-latching model substitute L742 for L716 in assembly number.

PAF 406-98 Available as Standard or Self Latching. Available as an Offset Manhole upon request.

For replacement parts on all available models please refer to **Appendix C-21, C-22, C-34 and C-35**

For ordering information please refer to **Appendix S-4, S-6, and S-7**

INTEGRAL RELIEF VALVE/10" FILL
LESS THAN 1 LITER LEAKAGE
SET PRESSURE ADJUSTMENT
INCREASED FLOW RATE
SECONDARY SAFETY LATCH

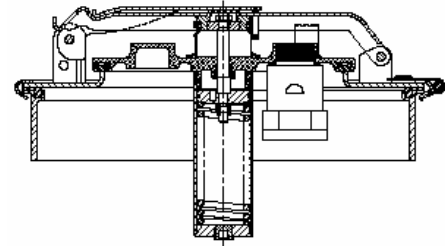

Pressure Relief Valve setting 3.63 psig
Rated Pressure Actuated Emergency Venting:
494,084 cu. ft. free air per hour @ 6.25 psig
Rated Liquid Flow Capacity
1335 GPM @ 5.0 psig

REPLACEMENT FOR PAF 9000 MODELS
INTEGRAL 10" FILL/PRESSURE RELIEF
VALVE WITH MC306 SET PRESSURE
LESS THAN 1 LITER LEAKAGE
SECONDARY SAFETY LATCH

Betts 16" & 20" PAF 306-98 Manhole with Integral Relief Valve/10" Fill

PAF manholes with integral latch style surge suppression relief valves are designed for use on DOT406 and replacement MC306 specification cargo tanks. Manholes are certified and marked in accordance with 49CFR178.345-5 with a test pressure of 36 psig. Manhole covers are 7 gauge steel or stainless and are secured to the tank weld collar with a clamp ring and bolt which can be easily removed to provide access into the tank.

The integral 10" Relief Valve provides emergency pressure relief and meets the 1 liter surge leakage limit imposed by 49CFR178.345-10(b) (3)(ii). The relief valve also serves as a 10" latch style fill which can be easily opened to provide access for filling the tank or for inspection. Relief valves contain an adjustment feature to allow for fine tuning of set pressure in field. Other standard features include a heavy duty clamp ring, secondary safety latch and **Model 6238ALB** pressure-vacuum vent mounted in the 10" relief valve cover.

Manholes are available with a self-latching feature that allows the 10" relief valve/fill cover to drop and securely latch upon movement of the tank if the cover is inadvertently left open. For self-latching model substitute L742 for L716 in assembly number.

PAF 406-98 Available as Standard or Self Latching. Also available as an Offset Manhole.

For replacement parts on all available models please refer to **Appendix C-23, C-24, C-36 and C-37** to see a breakdown of parts for these items
For ordering information please refer to **Appendix S-4 and S-7**

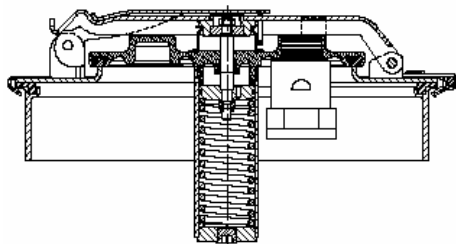

Pressure Relief Valve setting 3.0 psig
Rated Pressure Actuated Emergency Venting:
250,000 cu. ft. free air per hour @ 5.0 psig
Rated Liquid Flow Capacity 1012 GPM @ 5.0 psig

Refer to appendix number for a **full parts breakout** and **ordering information** on all chemical manholes

Betts 10" Pressure FIII

Model 8370

Threaded hold-downs and 6" or 10" collar.

Appendix C-38

Appendix S-7



Betts 20" Full Opening Manhole

Model 8310

Threaded hold-downs, heavy duty hinges, and 4", 6", or 10" collar. Full 20" opening allows for safe entrance for cleaning and inspecting tank.

Appendix C-39

Appendix S-8

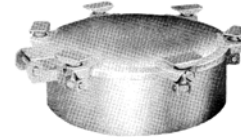

Betts 20" Full Opening Manhole

Model 8327

Threaded hold-downs, low profile, 4", 6", or 10" high collar available. Full 20" opening allows for safe entrance for cleaning and inspecting tank.

Appendix C-40

Appendix S-8



Betts 10" Pressure FIII (ASME Type)

Model 8368

ASME symbol and data provided, threaded hold-downs, and 6" or 10" collar available. Conforms to ASME Section VIII, Division 1.

Appendix C-43

Appendix S-9



10" Pressure FIII (ASME Type)

Model 8369

ASME symbol and data provided, threaded hold-downs, and 6" or 10" high collar. Conforms to ASME Section VIII, Division 1.

Appendix C-43

Appendix S-9



20" Full Opening Manhole with 10" FIII (ASME Type)

Model 8387

ASME symbol and data provided, threaded hold-downs, and 6" or 10" high collar. Conforms to ASME Section VIII, Division 1.

Appendix C-44

Appendix S-9



20" Full Opening Manhole (ASME Type)

Model 8350

ASME symbol and data provided, threaded hold-downs, and 6" or 10" high collar. Conforms to ASME Section VIII, Division 1.

Appendix C-45

Appendix S-9



20" Full Opening Manhole

Model 8355

Threaded hold-downs, 6" or 10" high collar available. Full 20" opening allows for safe entrance for cleaning and inspecting tank.

Appendix C-46

Appendix S-10



10" Pressure FIII (ASME Type)

Model 8261

ASME symbol and data provided, threaded hold-downs, and 6" or 10" high collar. Conforms to ASME Section VIII, Division 1.

Appendix C-47

Appendix S-10



20" Full Opening Manhole (ASME Type)

Model 8205

ASME symbol and data provided, threaded hold-downs, and 6" or 10" high collar. Conforms to ASME Section VIII, Division 1.

Appendix C-48

Appendix S-10



20" Full Opening Manhole with 10" FIII (ASME Type)

Model 8260

ASME symbol and data provided, threaded hold-downs, 6" or 10" high collar available, and designed for rubber lining. Conforms to ASME Section VIII, Division 1.

Appendix C-49

Appendix S-10



20" Full Opening Manhole (ASME Type)

Model 8380

ASME symbol and data provided, threaded hold-downs, and 6" or 10" high collar available. Conforms to ASME Section VIII, Division 1.

Appendix C-50

Appendix S-10



24" Full Opening Manhole (ASME Type)

Model 8324

ASME symbol and data provided, threaded hold-downs, and 6" or 10" high collar available. Conforms to ASME Section VIII, Division 1.

Appendix C-51

Appendix S-11



16" Full Opening Manhole (ASME Type)

Model 8303

ASME symbol and data provided, threaded hold-downs, and 6" or 10" high collar available. Conforms to ASME Section VIII, Division 1.

Appendix C-52

Appendix S-11



18" Full Opening Manhole (ASME Type)

Model 8418

ASME symbol and data provided, threaded hold-downs, and 6" or 10" high collar available. Conforms to ASME Section VIII, Division 1.

Appendix C-53

Appendix S-11



Parts breakouts for all manholes can be found in **Appendix C-1 thru C-53**. Ordering information for all chemical manholes can be found in **Appendix S-7 thru S-11**.

PPV VENT
FLOW RATED & MARKED
THREADED HOLD-
DOWNS
6" (152.4mm) HIGH
COLLAR PROVIDED

**Betts 20" Full Opening Manhole with 10" Relief Valve (PAF 450 Style)
Model 9730**

Betts 20" full opening manholes are fabricated for greater strength and less weight. Full 20" opening assures safe entrance for inspection or cleaning of tank.

The "Pressure Relief Valve" is set to open at not less than 3 psig and at 5 psig provides a capacity of 375,000 cubic feet of free air per hour of the emergency venting for fire exposure as required by DOT MC306 and NFPA385 and 407*.

For a list of replacement parts and full breakout please refer to **Appendix C-41**
For ordering information please refer to **Appendix S-8**



**Betts 20" Full Opening Manhole with 8" Relief Valve
Model 8311**

Betts 20" full opening manhole is fabricated for greater strength with less weight. Full 20" opening assures safe entrance for inspection or cleaning of tank. Head is interchangeable with Betts Model 8310 manhole heads to allow for easy tank conversion from DOT406 to DOT 407 or DOT 412.

Model 8277ALTS 8" Bolted Surge Suppression Pressure Relief Valve provides emergency pressure relief in accordance with DOT 406 requirements and meets the 1-liter surge leakage limit imposed by 49CFR178.345-10(b)(3)(ii). Relief valve is constructed of stainless steel and epoxy coated aluminum to minimize corrosion and features Teflon encapsulated seals for compatibility with a wide range of products.

Pressure Relief Valve Setting 3.63 psig.

Rated Pressure Actuated Emergency Venting: 426,409 cu. ft. free air per hour @ 6.25 psig.

Rated Liquid Flow Capacity: 1205 GPM @ 5.0 psig.

For a list of replacement parts and full breakout please refer to **Appendix C-42**
For ordering information please refer to **Appendix S-8**



Parts breakouts for all manholes and many other items can be found in the Appendix. Please refer here for replacement parts.